

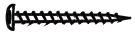







FERRAGENS

14	A		Parafuso 4X40
25	B		Prego 10X10
02	C		Parafuso 5X40
02	D		Pés
16	E		Parafuso 3,5X14
04	F		Parafuso 3,5X25
04	G		Dobradiças
04	H		Suporte Prateleira

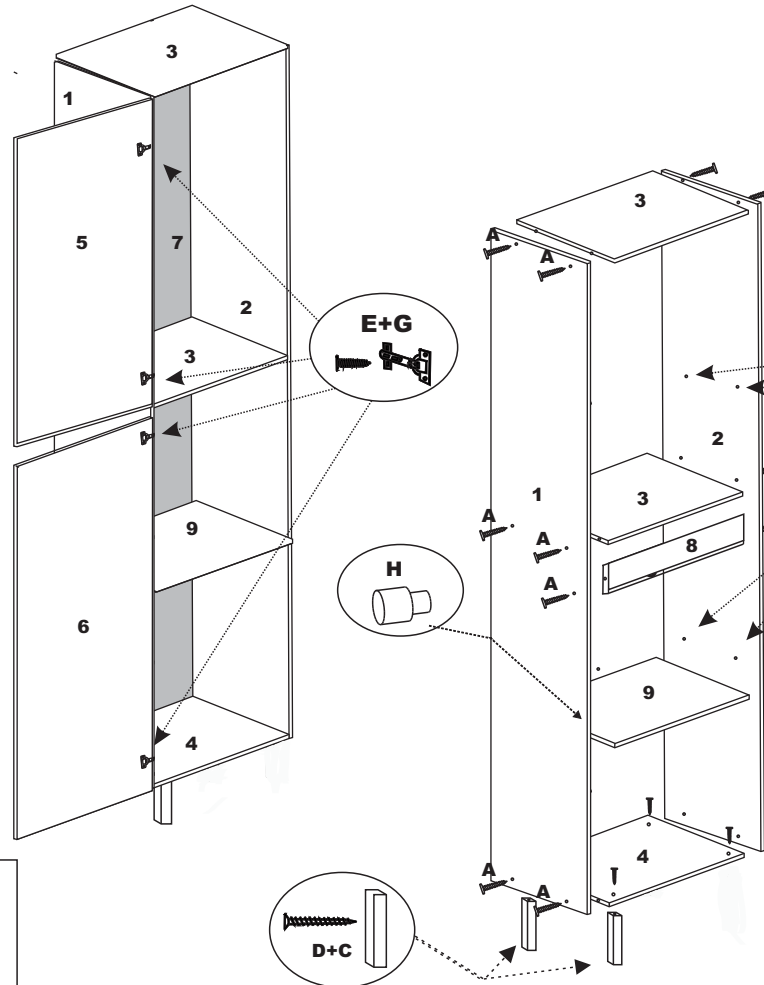

Para unir o paineleiro ao restante do kit utilizar estes furos passantes com os parafusos F (3,5X25)

Em função do designer do produto não possuir puxadores, a peça nº 8 fica recuada em relação as peças nº 5 e 6, possibilitando assim a abertura das portas.

