









FERRAGENS

14	A		Cavilhas 6 x 30
18	B		Parafuso 4 x 40
14	C		Cantoneira Fixador 18x18
44	D		Parafuso 3,5 x 14
04	E		Dobradiça
50	F		Prego 10 x 10
08	G		Parafuso 3,5 x 30
04	H		Pé de Rack 02,02,003

1º passo

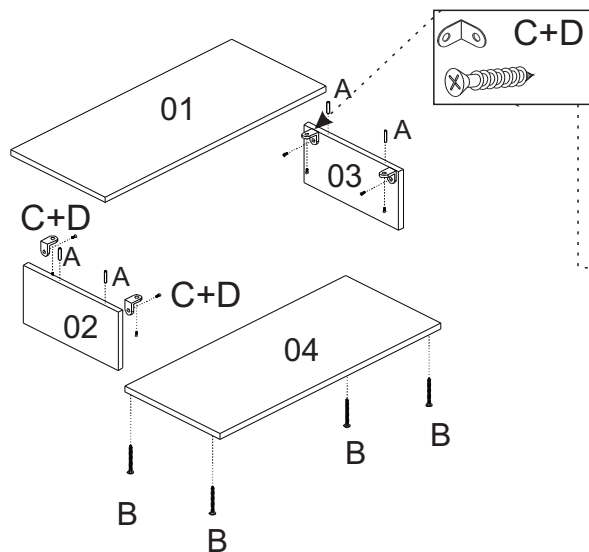

2º passo

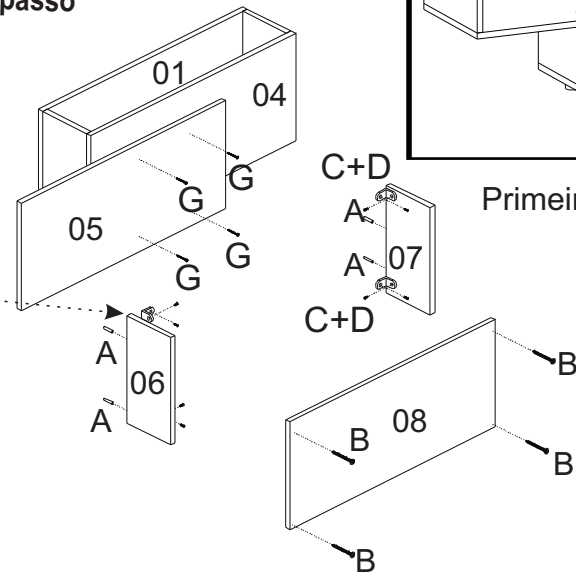

Primeiro unir a peça 05 na peça 04

3º passo

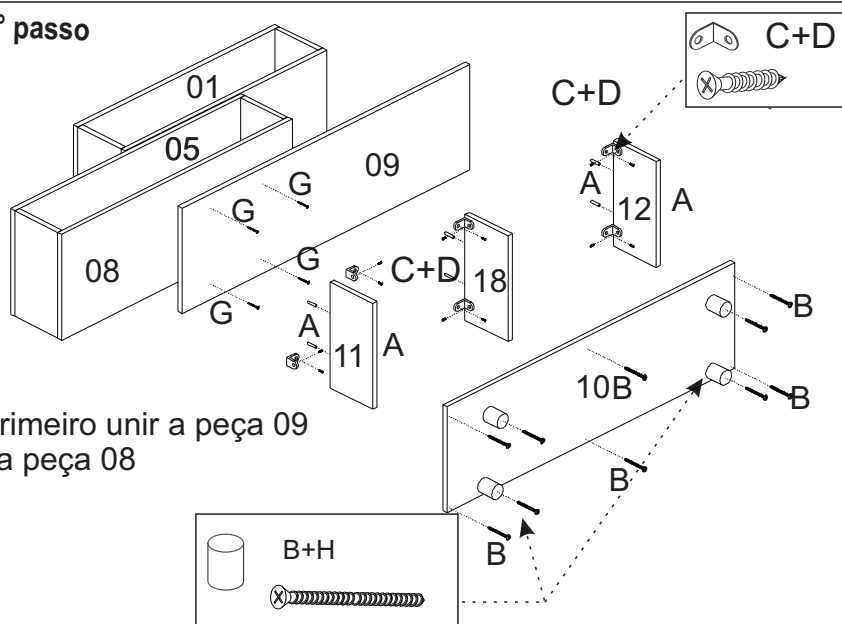

Primeiro unir a peça 09 na peça 08

4º passo

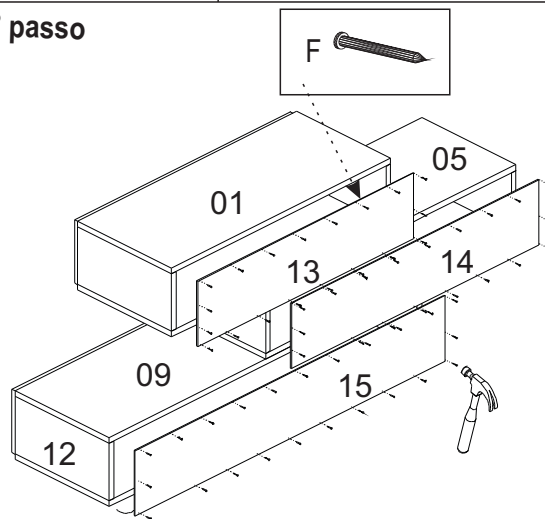

5º passo

