













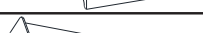

FERRAGENS

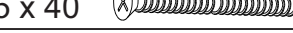
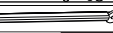
A	44	Parafuso 4 x 40	
B	28	Cavilha 6 X 30	
C	111	Parafuso 3,5 x 14	
D	14	Cantoneira 18x 18	
E	06	Puxador	
F	07	Sapata	
G	100	Prego 10 x 10	
H	12	Parafuso 3,5 x 25	
I	07	Parafuso 5 x 40	
J	03	Corrediça	
K	02	Parafuso União	
L	01	Bucha 8mm	
M	03	Dobradiça Com Calço 35	
N	04	Suporte Pino	
O	06	Dobradiça Com Calço 26	
P	04	Cola	
Q	01	Parafuso 5 x 60	
R	01	Suporte Aéreo	
S	87	Cavilha 6 x 15	

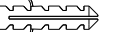
1° Passo

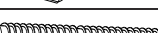
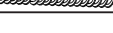
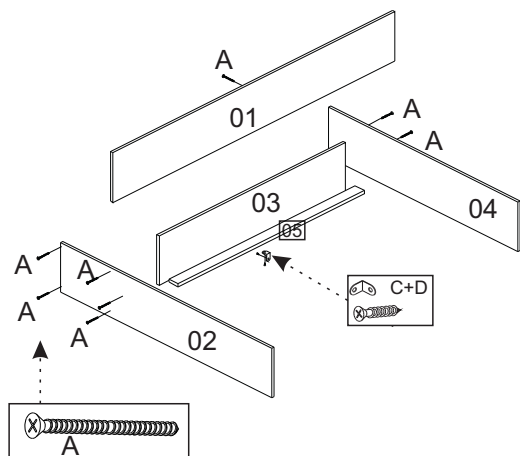

2° Passo

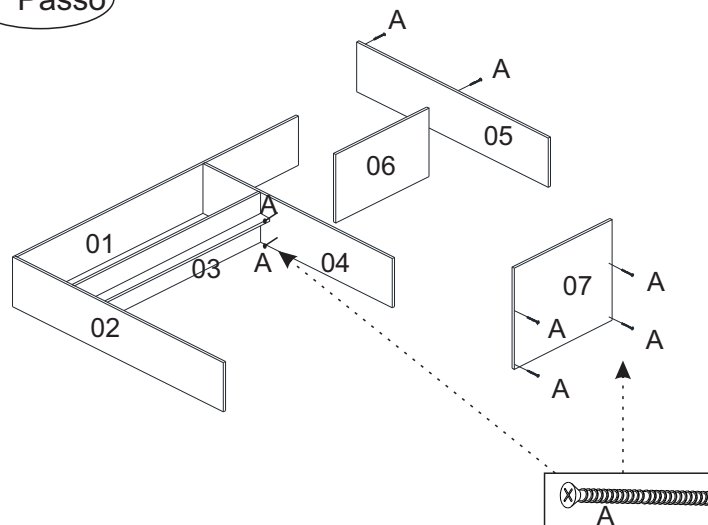

3° Passo

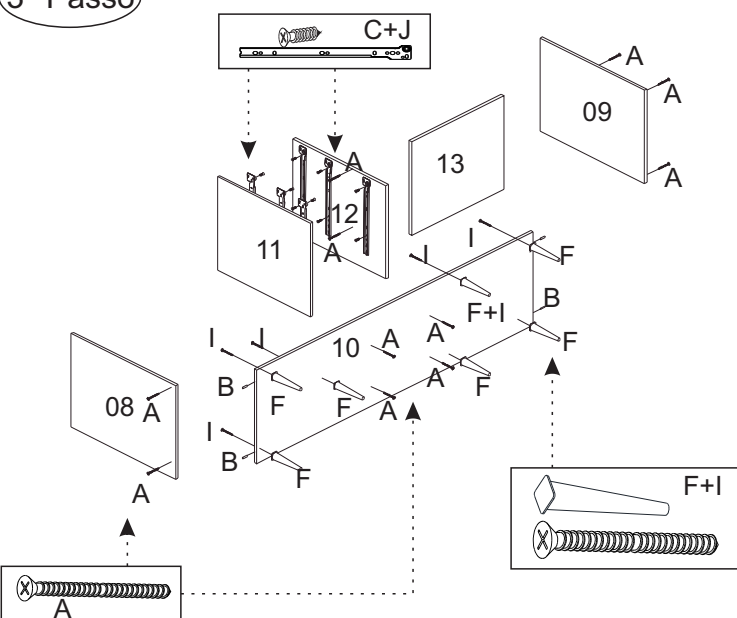

4° Passo

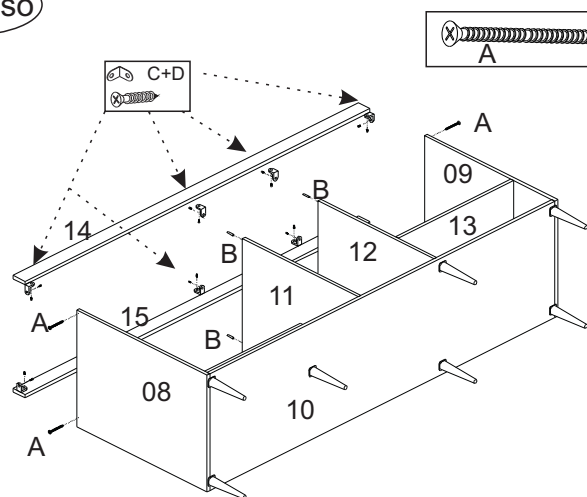

5° Passo

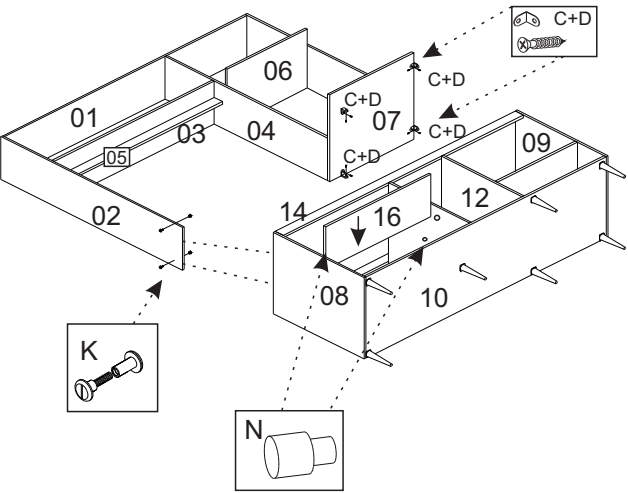

6° Passo

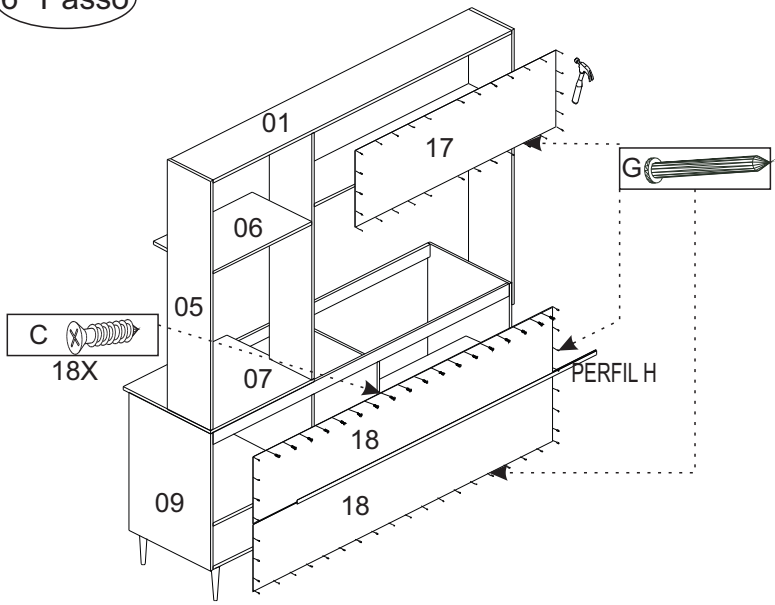

7° Passo

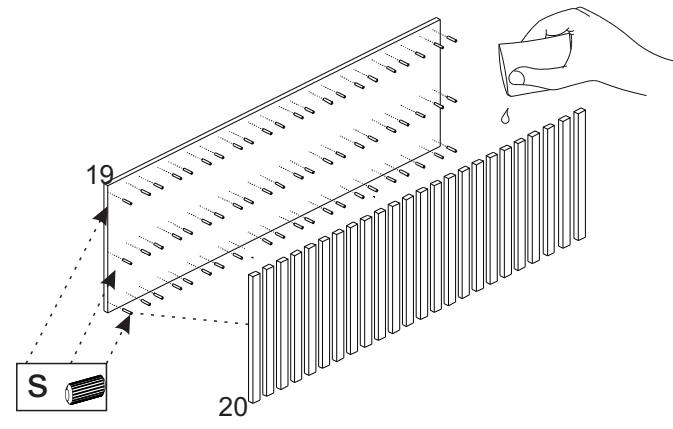

Colocar 3 cavilha S por Ripado + Cola P

8° Passo

3X

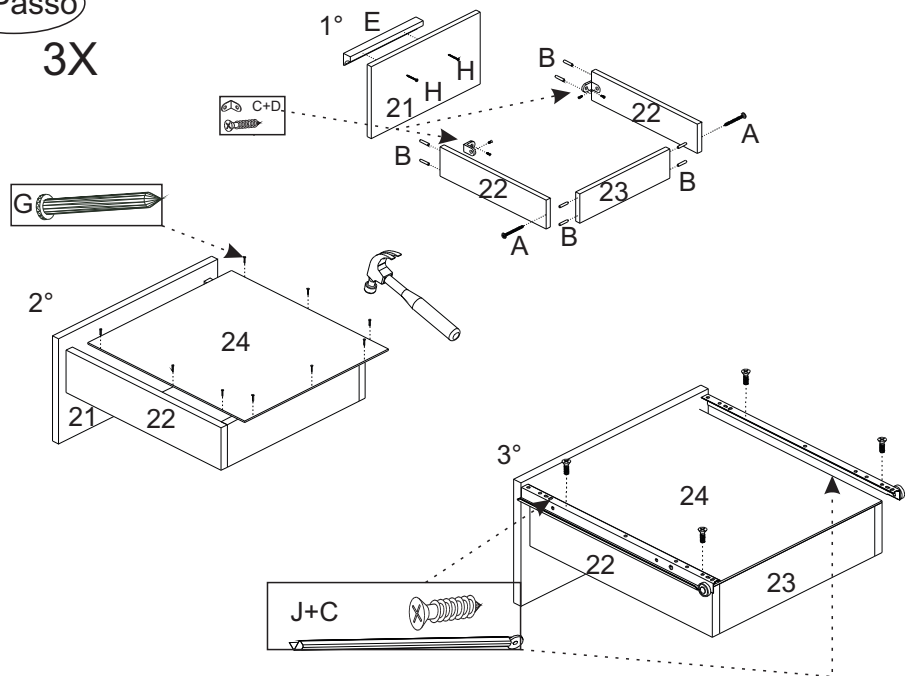

9° Passo

Fixar pelo lado de dentro da porta, fixar na parede... Kit Anti Tombamento

